



THREE PHASE ANGLE CONTROLLER

- ▶ Adapted to three phase star (without neutral) or delta connected loads (other wiring configurations on demand)
- ▶ Very low initial value regarding competition
- ▶ Small housing.
- ▶ Large mains frequency and voltage range.
- ▶ Fully opto-isolated full cycle three phase, phase angle controller (balanced currents, less harmonics, ...)
- ▶ Lot of possible options on demand (ramps, additional settings...).

SGTA4651

Proportional Analog Voltage Control Input :

0-5VDC

300->510VAC

50A AC-51

Mains Voltage	Mains Frequency	Max AC-51 Current	Control Input	In / Out / Case Insulation	Type of connections	Dimensions (WxHxD)	Weight
300 to 510VAC	40 to 65Hz	50A (with heatsink)	0-5VDC	4kV	Round tabs	100x73.5x39.5 (mm)	350g

Fig. 1 INTERNAL DIAGRAM

Fig. 2 TYPICAL APPLICATION

Fig. 3 PHASE ANGLE CONTROL DESCRIPTION

LED status	Power output status	Remarks
○	OFF	One or several mains phase missing
⊕	OFF	Standby mode
⊖	ON	Phase angle control
●	ON	Full power

Proud to serve you

INPUT CHARACTERISTICS

ANALOG CONTROL INPUT	CHARACTERISTIC	LABEL	VALUE	INFO.
	Label		Control	
	Terminals		+B1 & -A2/B2	
	Control voltage range	Uc	0-5VDC	
	Release and control threshold	Ucsmin	0.15VDC	
	Full power control threshold	Ucsmax	4.85VDC	
	Max. voltage (direct & reverse)	Ucmax	32VDC	
	Input impedance	Re	100kΩ	
SUPPLY INPUT	Label		Supply	
	Terminals		+A1 & -A2/B2	
	Operating voltage range	Us	Filtered 8-32VDC	
	Max. consumption	Is	15mA	See fig. 6

OUTPUT CHARACTERISTICS

POWER CIRCUIT	CHARACTERISTIC	LABEL	VALUE	INFO.
	Mains voltage range	Ue	300 -> 510VAC	
	Non-repetitive peak voltage	Uep	1200V	
	Overvoltage protection	VDR	Built-in 510V size 14 varistors	
	Maximum nominal current	Ithmax (AC51)	50A	With heatsink (See fig. 8)
	Non-repetitive peak overload current (1 cycle of 10ms)	ITSM	550A	See fig. 8
	Melting limit for choosing the protective fuses	I²t	1500A²s	@10ms
	Minimum load current	Iemin	100mA	
	Maximum leakage current	Ielk	7mA	@400VAC 50Hz
	Load power factor	Pf	0.8->1	
	Mains frequency range	F	40->65Hz	
	Max. off-state voltage rise	dv/dt	500V/μs	
	Protection against fast voltage transients		Built-in RC network	
	Max. current rise	di/dt	50A/μs	
	On-state voltage drop	Ud	$0.9 \times V_{to} \times I_{th} + r_t \times I_{th}^2$	
	On-state resistance	rt	12mΩ	@125°C
	On-state voltage	Vto	0.9V	@125°C
	Maximum junction temperature	Tjmax	125°C	
	Junction/case thermal resistance per power element	Rthjc	0.45K/W	Total = 3 power elements
	Built-in heatsink thermal resistance vertically mounted	Rthra	4K/W	@ΔTra=60°C
	Heatsink thermal time constant	Tthra	15min	@ΔTra=60°C
	Inputs/case/power outputs insulation voltages	Uimp	4kV	
	Isolation resistance	Rio	1GΩ	
	Isolation capacitance	Cio	<8pF	
	Storage ambient temperature	Tstg	-40->+100°C	
	Operating ambient temperature	Tamb	-40->+90°C	See fig. 7
	Max. case temperature	Tc	100°C	

GENERAL INFORMATION

CONNECTIONS	Connections		Power	Input	
	Type		Round tabs		
	Screwdriver (advised)		Philips™ Nr2	Philips™ Nr1	
	Tightening torque (advised)		1.8Nm	0.8Nm	
MISC.	Housing		UL94V0		
	Mounting		Panel – 4 x M4, 1.5Nm		
	Noise level		No Noise		
	Weight		350g		

STANDARDS

GENERAL	Standards		EN60947-4-3	
	Protection level		IP00	
	Protection against direct touch		No	
	CE marking		Yes	
	UL, cUL and VDE approvals		Pending	

	TYPE OF TEST	STANDARD	LEVEL	EFFECT
E.M.C. IMMUNITY	E.S.D. (Electrostatic discharges)	EN61000-4-2	8kV (air) 4kV (touch)	No effect
	Radiated electromagnetic fields	EN61000-4-3	10V/m	No effect
	Fast transients bursts	EN61000-4-4	2kV direct coupling on the power side 2kV coupling by clamp on the input side	No effect
	Electric chocks	EN61000-4-5	1kV direct coupling differential mode (input and output) 2kV direct coupling common mode (input and output)	No effect
	Voltage drop	EN61000-4-11	-	

E.M.C. EMISSION	Radiated and conducted disturbances	NFEN55011	<p>The conducted or radiated disturbances generated by solid-state relays depend on the wiring and load configuration.</p> <p>The test method recommended by the European standards and concerning electromagnetic compatibility leading to results far from reality, we decided to advise our customer in order to adapt their filtering scheme to their application.</p> <p>Please contact us if you are concerned about E.M.C.</p>
------------------------	-------------------------------------	-----------	--

TRANSFERT CHARACTERISTIC

Fig. 4

RMS Load Voltage Ratio vs. Input

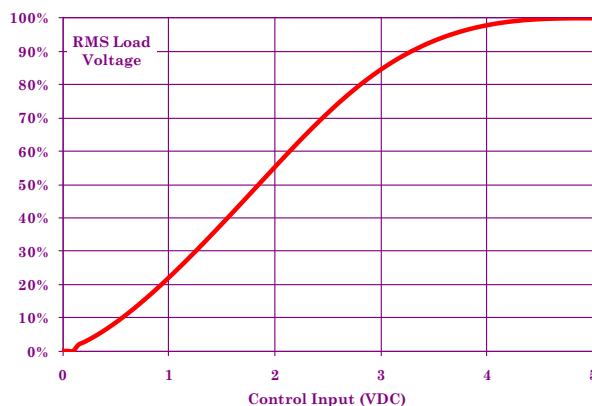

Nota :
 Response is linear in switching angle.
 (Possibility of response linearly regarding U² on demand)

CHARACTERISTIC CURVES

Fig. 5 INPUT CHARACTERISTIC

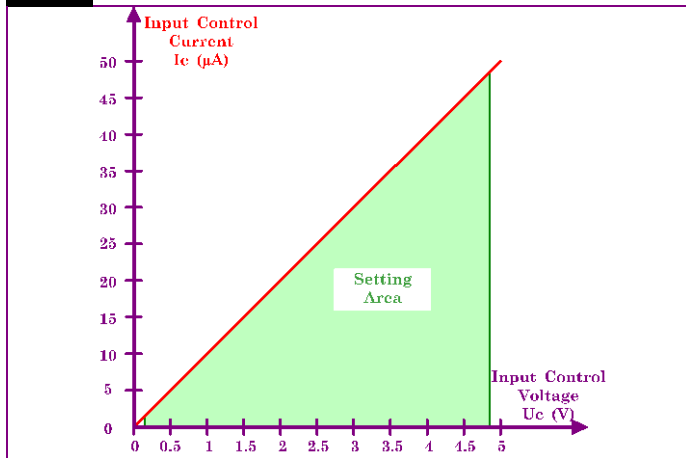

Fig. 6 POWER SUPPLY CHARACTERISTIC

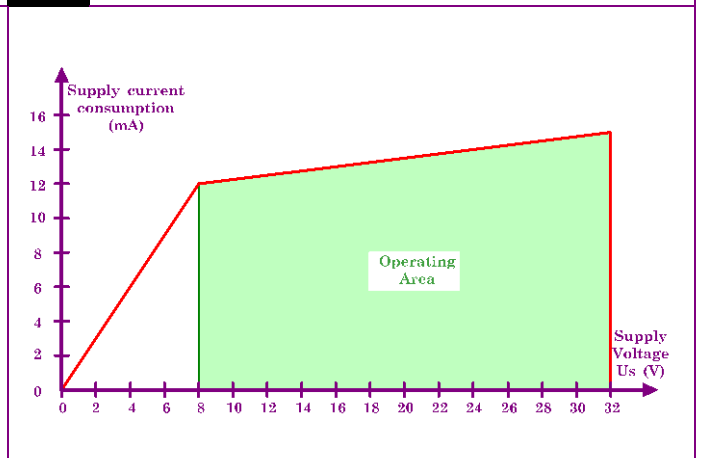

Fig. 7 POWER DISSIPATION AND LOAD CURRENT VS AMBIENT TEMPERATURE

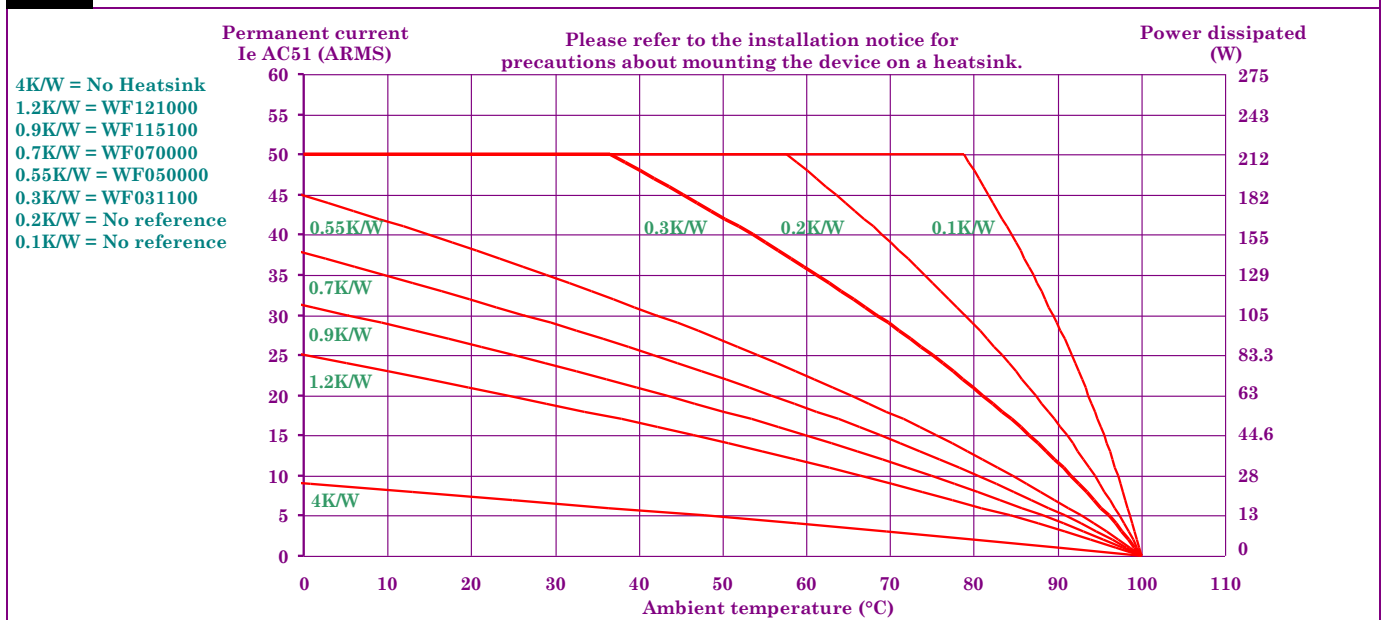
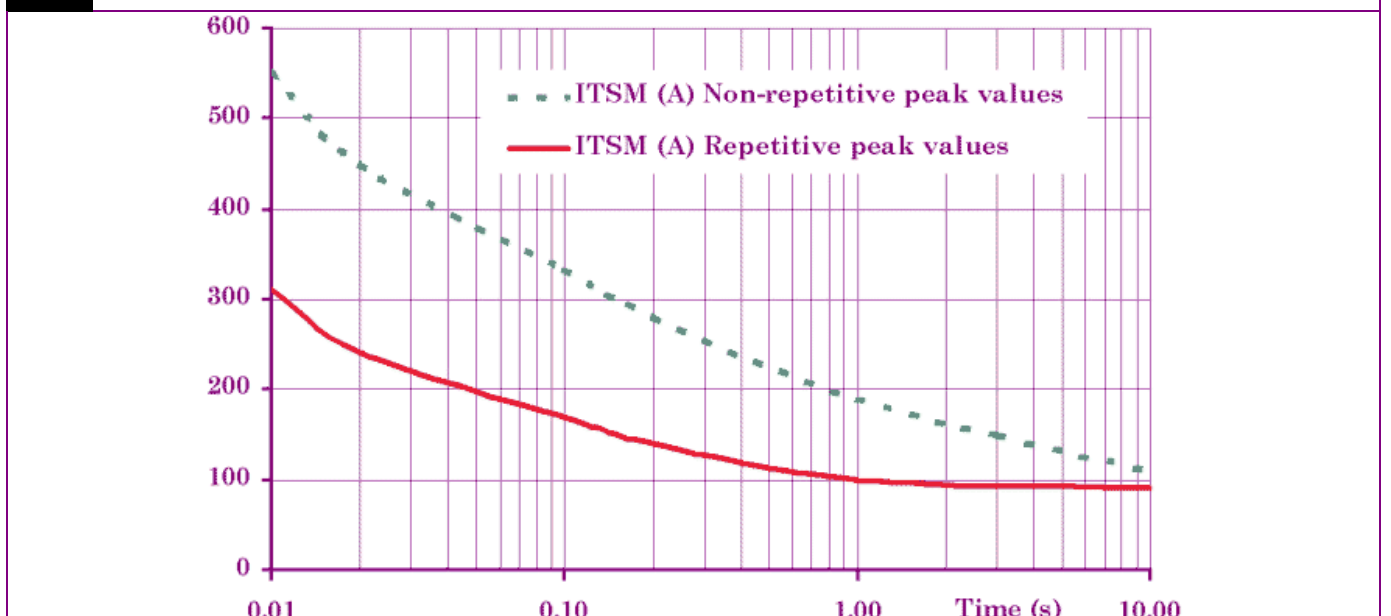

Fig. 8 CURRENT OVERLOAD CHARACTERISTIC (ITSM PER POWER ELEMENT)





DIMENSIONS AND ACCESSORIES

Fig. 9

DIMENSIONS

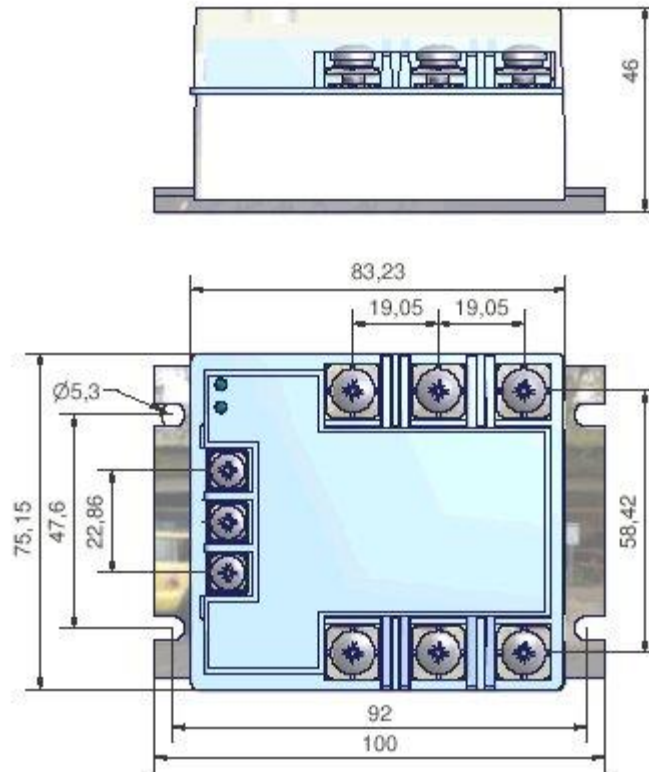
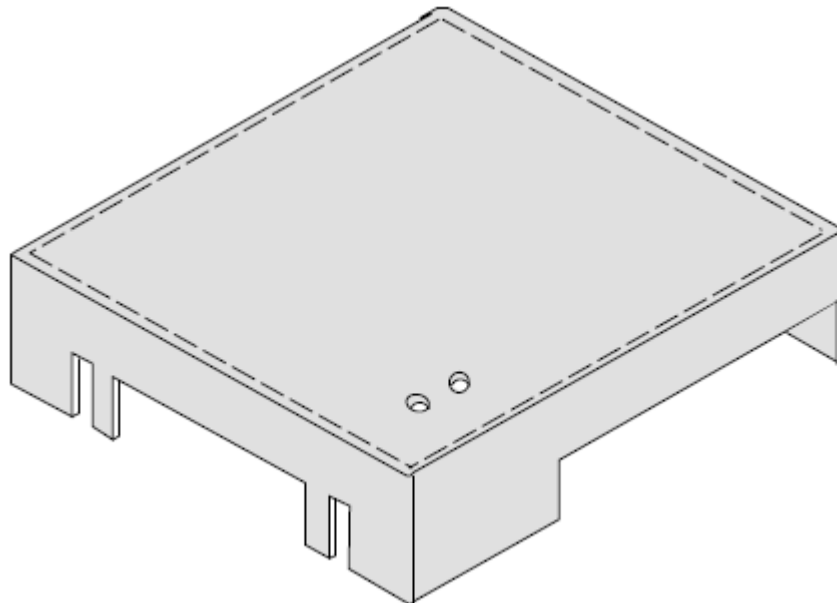

Fig. 10

ACCESSORIES



Protective cover 1K199000

