

Three Phase Solid State Relays

- Solid State Relay for resistive loads with integrated heatsink .
- DIN rail or panel mounting
- Back to back thyristors with TMS² technology
- 50A Thyristors size with $I^2t > 1500A^2s$ (*)
- 10-30 VDC control voltage with input status LED
- Overvoltage protection by integrated VDR
- IP20
- Designed in conformity with UL, EN60950 and IEC60947-4-3
- No tool needed for mounting and dismounting or
DIN rail or direct mouting on panel

SIT865570
(SVT865570-WH)
24-520 VAC - 3 x 50A
(AC-51 : 3 x 22 ARMS @40°C)



(*) : on request : model with I^2t 5000A²s up to 20000A²s



(SVT865570)

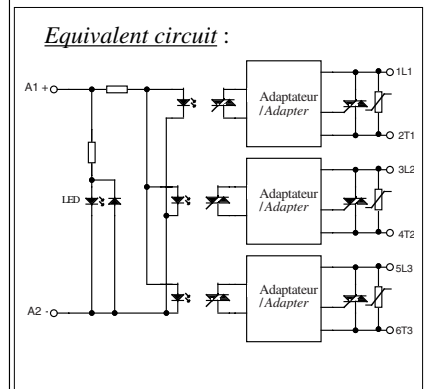
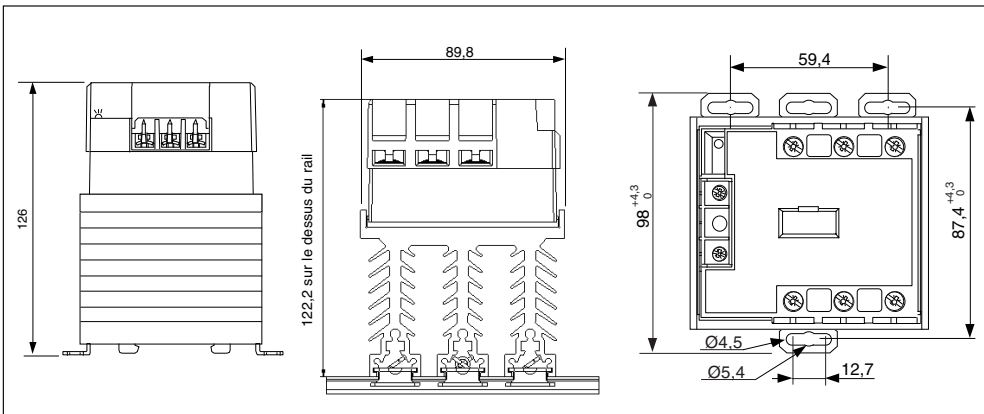

Equivalent circuit :

Control characteristics (at 20°C)

Parameter	Symbol	DC			Unit
		Min	Nom	Max	
Control voltage	Uc	10	24	30	V
Courant de commande /	Ic	10	32	42	mA
Release voltage	Uc off	4			V
Input internal resistor fig.1	Rc	560			Ω
Reverse voltage	Urv	30			V

Input-output characteristics (at 20°C)

Input-output isolation @500m	Ui	4000		VRMS
Output-case isolation @500m	Ui	3300		VRMS
Rated impulse voltage	Uimp	4000		V

General characteristics

Parameter	Conditions	Symbol	Typ.	Unit
Poids/Weight			1000	g
Storage temperature range			-40 / +100	°C
Operating temperature range			-40 / +80	°C

fig. 1 : Control characteristic

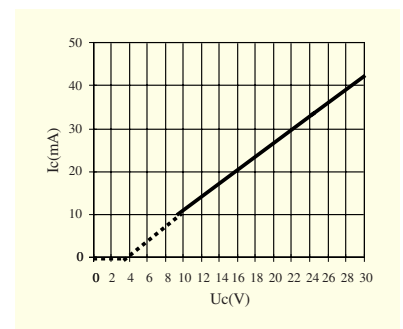

Input resistor means high input immunity
 (more than 1kV according IEC1000-4-4 and 5)

Proud to serve you

Output characteristics (at 20 °C)

Parameter	Conditions	Symbol	Value	Unit
Load voltage		Ue	400	V rms
Minimum Operating range		Uemin	24	V rms
Maximum Operating range	(480Vrms + 10%)	Uemax	520 (*)	V rms
Peak voltage		Up	1200 (*)	V
(*) Clamping voltage	by VDR	Uclamp	850	V
Synchronizing level		Usync	35	V
Latching voltage	Ie nom	Ua	10	V
AC-51 no permanent nominal current	(see Fig. 2)	Ie AC-51	3x50	A rms
AC-51 nominal current @25°C	(see Fig. 2)	Ie AC-51	3x22	A rms
Non repetitive overload current	tp=10ms (Fig. 3)	Itsm	550 (typ 720)	A
On state voltage drop	@ Ie nom	Vd	1,4	V
Off state leakage current	@Ue, 50Hz	Ilk	1	mA
Minimum load current		Ie min	5	mA
Turn on time	Uc nom DC ,f=50Hz	ton max	10	ms
Turn off time	Uc nom DC ,f=50Hz	toff max	10	ms
Operating frequency range		f	10-400	Hz
Off state dv/dt		dv/dt	500	V/μs
Maximum di/dt non repetitive		di/dt	50	A/μs
I2t (<10ms)		I2t	1500 (typ 2600)	A2s
Conducted immunity level in conformity with IEC 1000-4-4 (burst)	IEC 1000-4-4 (burst)		2kV criterion B	
Conducted immunity level in conformity with IEC 1000-4-5(schocks)	IEC 1000-4-5(schocks)		2kV criterion A	
Conformity	EN60947-4-3 ; UL approved and designed in conformity with EN60950			

thermal curves :**curve 1 :**

with ventilation in the heatsink (> 1m/s)

curve 2 :

working in normal conditions with a small ventilation in the cabinet

curve 3 :

according with IEC60947-4-2 in a closed cabinet without any ventilation.

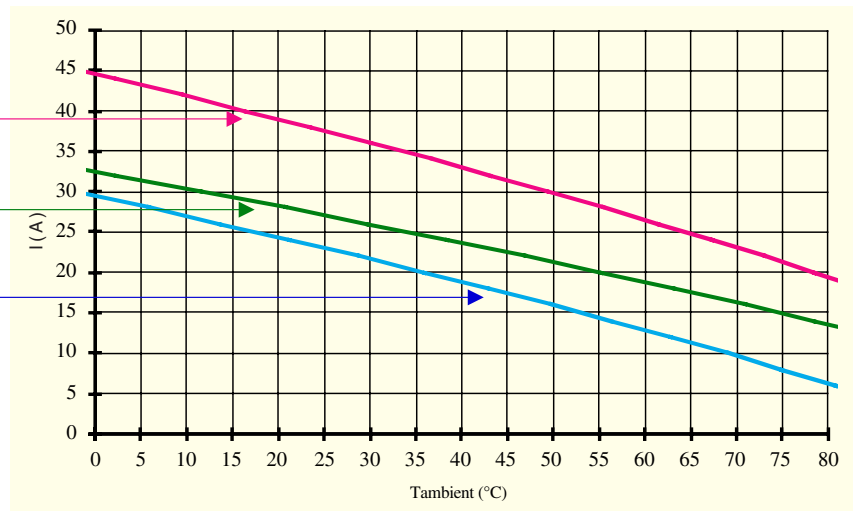
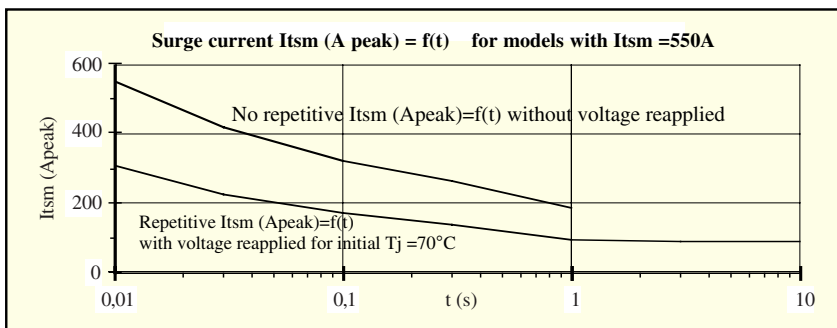

Fig.3 : Overload current curves



1 -No repetitive Itsm is given without voltage reapplied for the determination of the protection.

2 -Repetitive Itsm is given for inrush current with initial $T_j = 70^\circ\text{C}$. The repetition of the surge current decrease the lifetime SSR's .





Cautions :



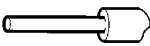

* Semiconductor relays don't provide any galvanic insulation between the load and the mains.

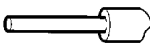
Proud to serve you

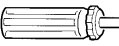
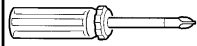
celduc®

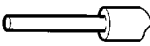
r e l a i s

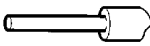
SVT						Wiring of the control circuit:	
NUMBER OF WIRES				SCREWDRIVER TYPE		MINIMUM TORQUE	
1		2					
SOLID (No ferrule)	FINE STRANDED (With ferrule)	SOLID (No ferrule)	FINE STRANDED (With ferrule)				
						N.m	
0,75 ... 2,5 mm ²	0,75 ... 2,5 mm ²	0,75 ... 2,5 mm ²	0,75 ... 2,5 mm ²	0,8 x 5,5 mm	POZIDRIV 2	1,2	

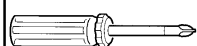
SVT						Wiring of the power circuit:	
NUMBER OF WIRES				SCREWDRIVER TYPE		MINIMUM TORQUE	
1		2					
SOLID (No ferrule)	FINE STRANDED (With ferrule)	SOLID (No ferrule)	FINE STRANDED (With ferrule)				
						N.m	
1,5 ... 10 mm ²	1,5 ... 6 mm ²	1,5 ... 10 mm ²	1,5 ... 6 mm ²	0,8 x 5,5 mm	POZIDRIV 2	1,8	

