

# Contacteur Statique Triphasé Power Three Phase Solid State Contactor

## SIT865390 (SVT865390-WH)

24-520 VAC - 3 x 50A  
(AC-51 : 3 x 22 ARMS)  
(AC-53 : 3 x 12 ARMS)  
AC/DC control

- ❑ Contacteur statique synchrone Triphasé prêt à l'emploi adapté à tout type de charges  
*Ready to use Three phase ZeroCross Solid State Contactor designed for all types of loads.*
- ❑ Sortie thyristors hautes performances technologie TMS<sup>2</sup> (\*) permettant une longue durée de vie: **24 à 520VAC 50A** ( $I^2t > 1500A^2s$ )  
*New High Efficiency Back to back thyristors on output with TMS<sup>2</sup> technology(\*) for a long lifetime expectancy: 24 to 520VAC 50A  $I^2t > 1500A^2s$  (\*\*)*
- ❑ Tension de commande 8,5 -30VDC ou 10-30VAC  
LED de visualisation sur l'entrée de couleur verte.  
*Control range: 8,5-30VDC or 10-30VAC.  
Green LED visualization on the input.*
- ❑ Haute Immunité et Protection de la tension de sortie par RC et varistor.  
*High Immunity and output voltage protection by RC and VDR*
- ❑ Livré en standard avec dissipateur intégré montable sur rail DIN et protection contre le toucher IP20  
*Delivered with integrated heatsink for DIN rail mounting and with IP20 protection cover.*
- ❑ Construit en conformité aux normes EN60947-4-3 (IEC947-4-3) et EN60950/VDE0805 (Isolement renforcé) -UL-cUL  
*Designed in conformity with EN60947-4-3 (IEC947-4-3) and EN60950/VDE0805 (Reinforced Insulation) -UL-cUL*

(\*\*): Modèle 5000A<sup>2</sup>s sur demande ; 5000A<sup>2</sup>s model on request

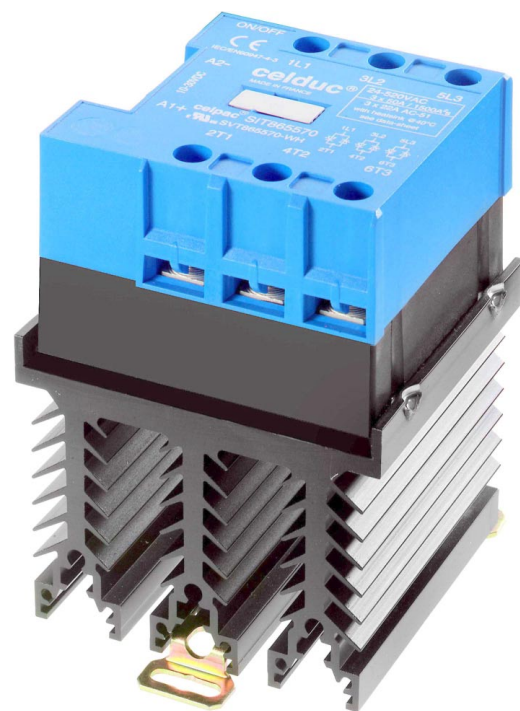

(SVT865390)

### Caractéristiques de commande (à 20°C) / Control characteristics (at 20°C)

Paramètre / Parameter	Symbol	AC-DC			Unit
		Min	Nom	Max	
Tension de commande / Control voltage : DC	Uc	8,5	24	30	VDC
Tension de commande / Control voltage : AC	Uc	10	24	30	VAC
Courant de commande / Control current (@ Uc )	Ic	15	50	65	mA
Tension de relachement/Release voltage	Uc off	4			V
Résistance interne / Input internal resistor fig.1	Rc		410		Ω
Tension inverse / Reverse voltage	Urv		polarity free		V

### Caractéristiques d'entrée-sortie (à 20°C) / Input-output characteristics (at 20°C)

Isolement entrée-sortie/Input-output isolation @500m	Ui		4000		VRMS
Isolement sortie-semelle/Output-case isolation @500m	Ui		3300		VRMS
Tension assignée isolement/ Rated impulse voltage	Uimp		4000		V

fig. 1 :Caractéristique d'entrée / Control characteristic

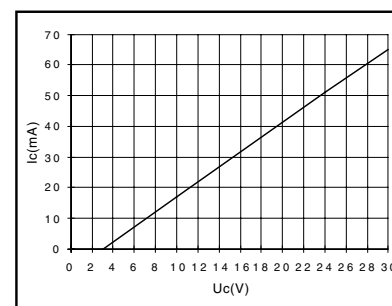

### General characteristics

Parameter	Conditions	Symbol	Typ.	Unit
Poids/Weight			1000	g
Température de fonctionnement / Ambient temperature (no icing, no condensation)			-40 / +100	°C
Température de stockage/ Storage temperature (no icing, no condensation)			-40 / +80	°C

(\*) : Thermo Mechanical Stress Solution

Proud to serve you

All technical characteristics are subject to change without previous notice.  
Caractéristiques sujettes à modifications sans préavis.

celduc®  
r e l a i s

**Caractéristiques de sortie / Output characteristics (at 25°C)**

Paramètre / Parameter	Conditions	Symbol	Min	Typ.	Max	Unit
Plage de tension utilisation / Operating voltage range		Ue	24	400	520	V rms
Tension de crête (écrêtage VDR)/ Peak voltage (VDR clamping)	@ 1mA	Up	1200 (950)			V
Niveau de synchronisme / Zero cross level		U <sub>sync</sub>			12	V
Tension minimum amorçage / Latching voltage	Ie nom	Ua	10			V
Courant nominal / nominal current (AC-51)	<b>Resistance</b>	Ie AC-51	<b>50 (see derating curve)</b>			A rms
Courant nominal / nominal current (AC-53)	<b>Motor</b>	Ie AC-53		<b>3*12A</b>		A rms
Courant surcharge / Non repetitive overload current	tp=10ms (Fig. 3)	I <sub>tsm</sub>	550	720		A
Chute directe à l'état passant / On state voltage drop	@ 25°C	Vt			0,9	V
Résistance dynamique / On state dynamic resistance		rt			12	mΩ
Puissance dissipée (max) / Output power dissipation (max value)		Pd	(0,9x0,9xIe + 0,012xIe <sup>2</sup> )*3			W
Résistance thermique jonction/semelle Thermal resistance between junction to case		Rthj/c		1 leg	0,45	K/W
Courant de fuite à l'état bloqué / Off state leakage current	@Ue typ, 50Hz	I <sub>lk</sub>			1	mA
Courant minimum de charge / Minimum load current		I <sub>emin</sub>	5			mA
Temps de fermeture / Turn on time	@Ue typ, 50Hz	ton max			20	ms
Temps d'ouverture / Turn off time	@Ue typ, 50Hz	toff max			30	ms
Fréquence utilisation/ Operating frequency range	F mains	f	0,1	50-60	800	Hz
dv/dt à l'état bloqué / Off state dv/dt		dv/dt	500			V/μs
di/dt max / Maximum di/dt non repetitive		di/dt			50	A/μs
I <sub>2t</sub> (<10ms)		I <sup>2</sup> <sub>t</sub>	1500	2500		A <sup>2</sup> s
Immunité / Conducted immunity level	IEC/EN61000-4-4 (bursts)		4kV criterion A			
Immunité / Conducted immunity level	IEC/EN61000-4-5 (surge)		4kV criterion A			
Protection court-circuit / Short circuit protection	voir/see page 6	Example	Fuse Ferraz gRC 25A/32A/50A			

**COURBES THERMIQUES / thermal curves:****curve 1 :**

with ventilation in the heatsink (> 1m/s)  
(avec ventilation significative du dissipateur)

**curve 2 :**

working in normal conditions with a small  
ventilation in the cabinet ( avec petite ventila-  
tion d'armoire)

**curve 3 :**

according with IEC60947-4-2  
in a closed cabinet without any ventilation.  
(absence totale de ventilation)

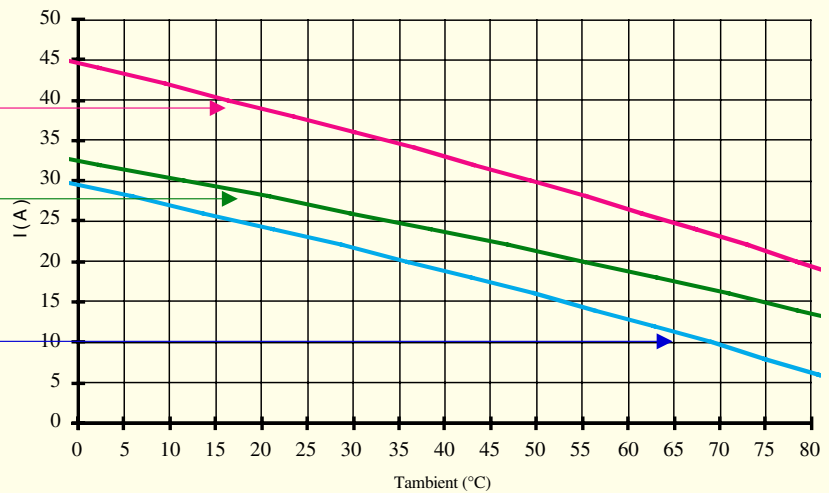

**1 -I<sub>tsm</sub> non répétitif** sans tension réappliquée est donné pour la détermination des protections.

1 - *No repetitive I<sub>tsm</sub> is given without voltage reapplied. This curve is used to define the protection (fuses).*

**2 -I<sub>tsm</sub> répétitif** est donné pour des surcharges de courant (T<sub>j</sub> initiale=70°C).

Attention : la répétition de ces surcharges de courant diminue la durée de vie du relais.

2 - *Repetitive I<sub>tsm</sub> is given for inrush current with initial T<sub>j</sub> = 70°C. In normal operation, this curve musn't be exceeded.*

*Be careful, the repetition of the surge current decreases the life expectancy of the SSR.*

fig 3 : Courants de surcharges / Overload currents

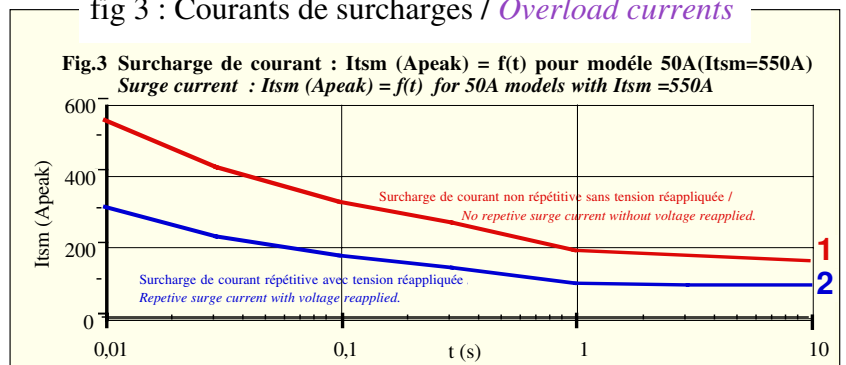

ISO 9001  
N° 1993/1106a

**celduc**<sup>®</sup>  
r e l a i s



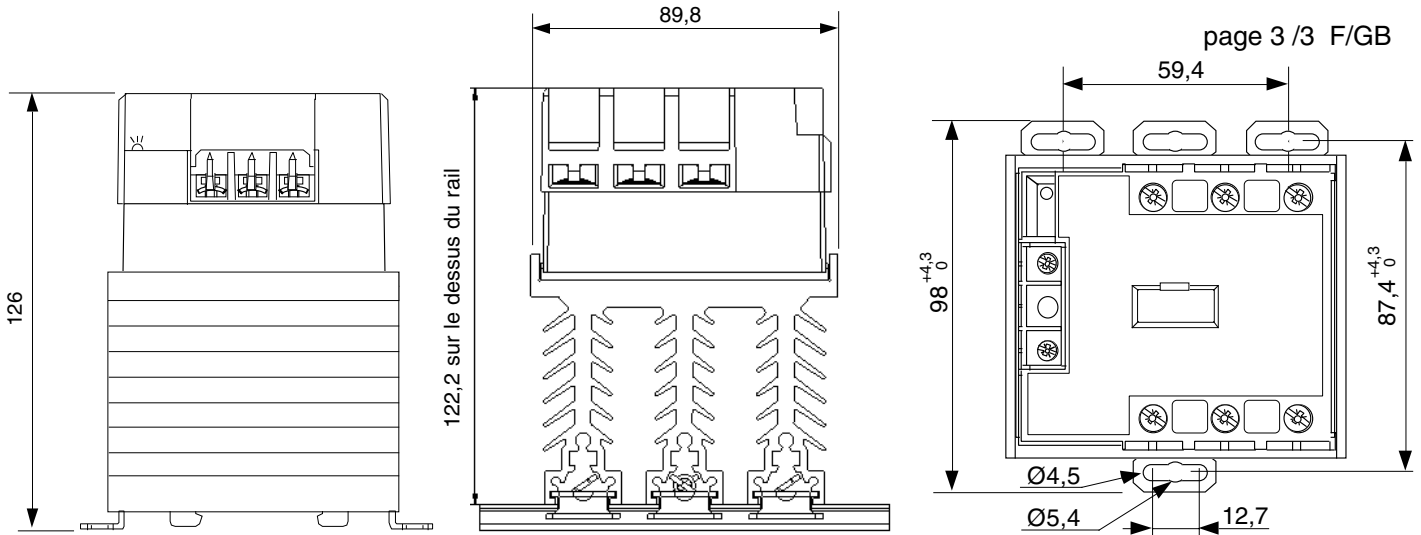

www.celduc.com

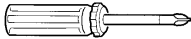
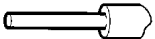
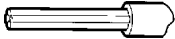
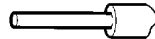
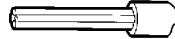
5 Rue Ampère B.P. 30004 42290 SORBIERS - FRANCE E-Mail : celduc-relais@celduc.com  
Fax +33 (0) 4 77 53 85 51 Service Commercial France Tél. : +33 (0) 4 77 53 90 20  
Sales Dept.For Europe Tel. : +33 (0) 4 77 53 90 21 Sales Dept. Asia : Tél. +33 (0) 4 77 53 90 19

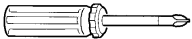
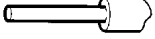

<b>SIT/SVT</b>				<b>Raccordement d'entrée / Control wiring</b>	
Nombre de fils / Number of wires				Modèle de tournevis / Screwdriver type	Couple de serrage recommandé Recommended Torque
1		2			
Fil rigide (sans embout) <b>SOLID</b> (No ferrule)	Fil multibrins (avec embout) <b>FINE STRANDED</b> (With ferrule)	Fil rigide (sans embout) <b>SOLID</b> (No ferrule)	Fil multibrins (avec embout) <b>FINE STRANDED</b> (With ferrule)		M4
					N.m
0,75 ... 2,5 mm <sup>2</sup> AWG18...AWG14	0,75 ... 2,5 mm <sup>2</sup> AWG18...AWG14	0,75 ... 2,5 mm <sup>2</sup> AWG18...AWG14	0,75 ... 2,5 mm <sup>2</sup> AWG18...AWG14	POZIDRIV 2	1,2

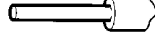
<b>celpac<sup>®</sup></b>				<b>Raccordement de puissance / Power wiring</b>	
Nombre de fils / Number of wires				Modèle de tournevis / Screwdriver type	Couple de serrage recommandé Recommended Torque
1		2			
Fil rigide (sans embout) <b>SOLID</b> (No ferrule)	Fil multibrins (avec embout) <b>FINE STRANDED</b> (With ferrule)	Fil rigide (sans embout) <b>SOLID</b> (No ferrule)	Fil multibrins (avec embout) <b>FINE STRANDED</b> (With ferrule)		M5
					N.m
1,5 ... 10 mm <sup>2</sup> AWG16...AWG8	1,5 ... 6 mm <sup>2</sup> AWG16...AWG10	1,5 ... 10 mm <sup>2</sup> AWG16...AWG8	1,5 ... 6 mm <sup>2</sup> AWG16...AWG10	POZIDRIV 2	2



ISO 9001  
N° 1993/1106a

**celduc<sup>®</sup>**  
r e l a i s

[www.celduc.com](http://www.celduc.com)

5 Rue Ampère B.P. 30004 42290 SORBIERS - FRANCE E-Mail : [celduc-relais@celduc.com](mailto:celduc-relais@celduc.com)  
 Fax +33 (0) 4 77 53 85 51 Service Commercial France Tél. : +33 (0) 4 77 53 90 20  
 Sales Dept.For Europe Tel. : +33 (0) 4 77 53 90 21 Sales Dept. Asia : Tél. +33 (0) 4 77 53 90 19

**APPLICATION TYPIQUE**

*Typical application:*

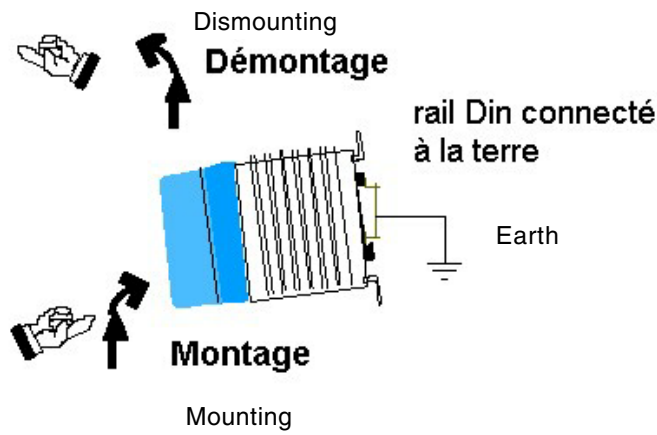
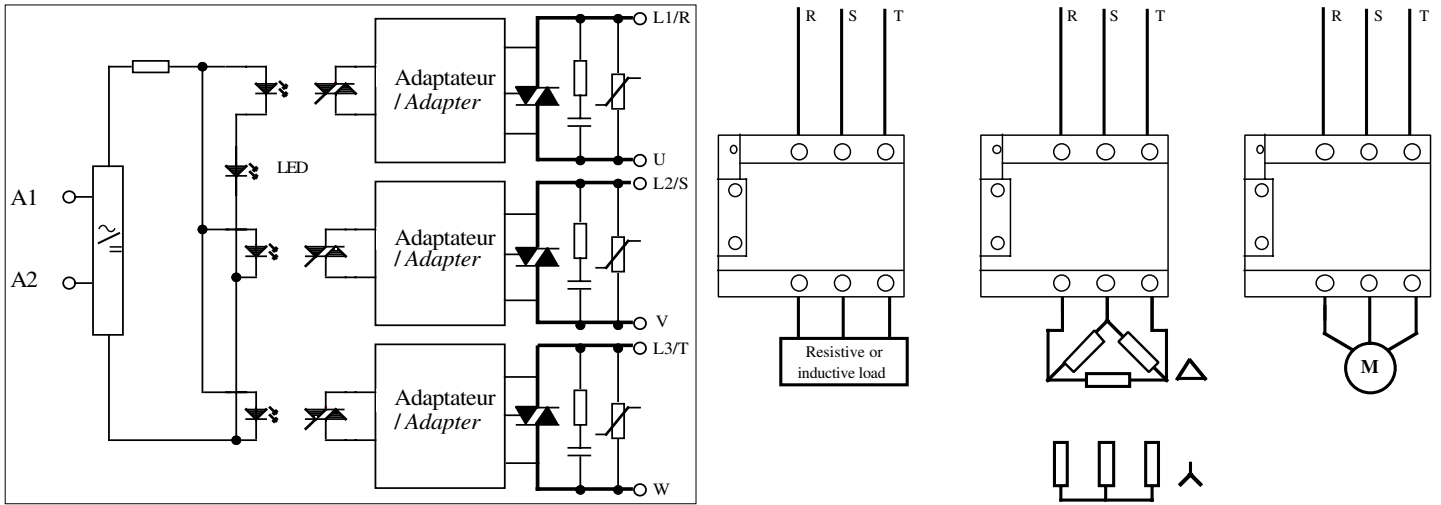

**celduc**<sup>®</sup>  
r e l a i s

[www.celduc.com](http://www.celduc.com)

5 Rue Ampère B.P. 30004 42290 SORBIERS - FRANCE E-Mail : [celduc-relais@celduc.com](mailto:celduc-relais@celduc.com)  
 Fax +33 (0) 4 77 53 85 51 Service Commercial France Tél. : +33 (0) 4 77 53 90 20  
 Sales Dept.For Europe Tel. : +33 (0) 4 77 53 90 21 Sales Dept. Asia : Tél. +33 (0) 4 77 53 90 19