

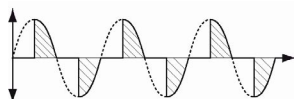

Gradateur angle de phase Phase angle controller



- ❑ Relais statique à entrée analogique permettant un contrôle en puissance de la charge par une variation en angle de phase
Analog switching Solid State Relay works for load power control in accordance with the phase angle principle.
- ❑ Sortie thyristors technologie TMS² (*) permettant une longue durée de vie : **Gamme de 90 à 600VAC 35 à 125A**
Back to back thyristors on output with TMS² () technology for a long lifetime expectancy : Range 90 to 600VAC and 35 to 125A*
- ❑ 4-20mA courant de commande. 4 mA correspondant à une puissance de sortie nulle et 20mA à pleine puissance.
LED de visualisation sur l'entrée de couleur verte.
*4-20mA control current. 4mA corresponds to no switching and 20mA to full sine wave.
Green LED visualization on the input.*
- ❑ Construit en conformité aux normes EN60947-4-3 (IEC947-4-3) et EN60950/VDE0805 (Isolement renforcé)
Designed in conformity with EN60947-4-3 (IEC947-4-3) and EN60950/VDE0805 (Reinforced Insulation)
- ❑ Protection IP20 par volets sur les bornes.
IP20 protection by flaps on terminals.

SO445420

Output : 90-280VAC 50A
Analog Input : 4-20mA



Microcontroller Inside



IP20

Dimensions :

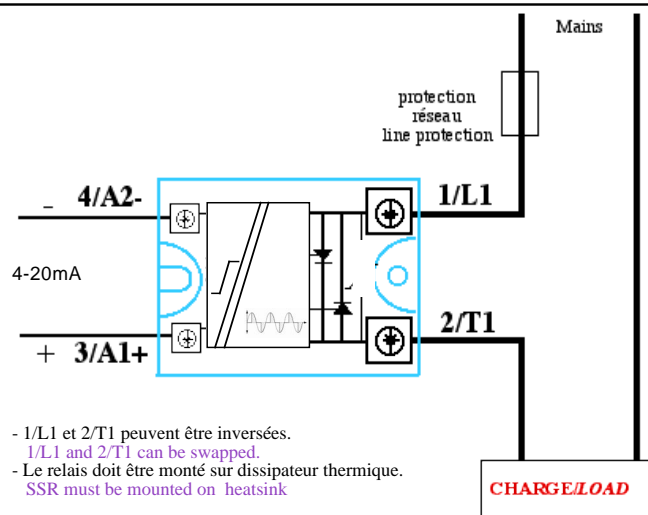
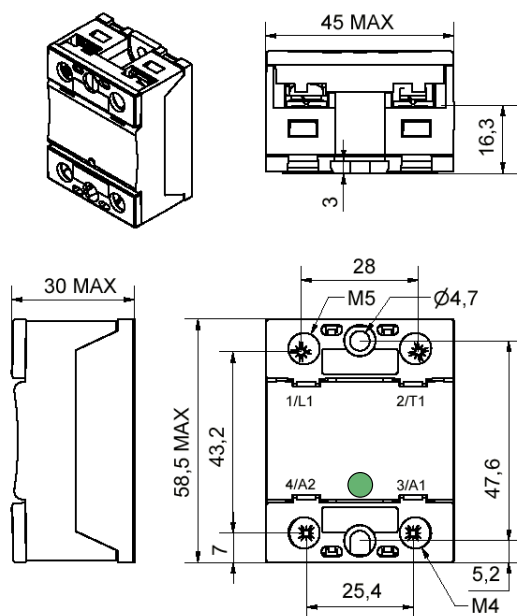

Application typique / Typical application:
10kW resistance (AC-51) - 230 VAC 50hz

(*) : Thermo Mechanical Stress Solution

Proud to serve you

All technical characteristics are subject to change without previous notice.
Caractéristiques sujettes à modifications sans préavis.

celduc®

r e l a i s

Caractéristiques d'entrée / Control characteristics (at 25°C)

Paramètre / Parameter	Symbol	DC			Unit
		Min	Typ	Max	
Courant de commande / Control current range	Ie	4-20			mA
Chute de tension / Voltage drop out	Ic	≤8VDC @ 20mA			V
Impédance d'entrée / Dynamic impedance	R	≥100			mΩ
LED d'entrée / Input LED		verte / green			
Protection Inverse / Reverse polarity protection		yes			
Courant maximum / Maximum allowed input current	Imax	50			mA

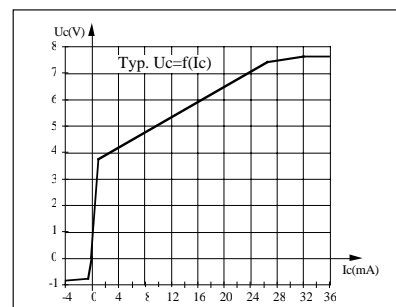
**Caractéristiques de sortie / Output characteristics (at 25°C)**

Paramètre / Parameter	Conditions	Symbol	Min	Typ.	Max	Unit
Plage de tension utilisation / Operating voltage range		Ue	90	230	280	V rms
Tension de crête / Peak voltage	@ 1mA	Up	600			V
Tension minimum amorçage / Latching voltage	Ie nom	Ua	10			V
Courant nominal / nominal current (AC-51)		Ie AC-51		50	60	A rms
Courant surcharge / Non repetitive overload current	tp=10ms (Fig. 3)	Itsm	550	720		A
Chute directe à l'état passant / On state voltage drop	@ 25°C	Vt			0,9	V
Résistance dynamique / On state dynamic resistance		rt			12	mΩ
Puissance dissipée (max) / Output power dissipation (max value)		Pd	0,9x0,9xIe + 0,012xIe ²			W
Résistance thermique jonction/semelle / Thermal resistance between junction to case		Rthj/c			0,45	K/W
Courant de fuite à l'état bloqué / Off state leakage current	@Ue typ, 50Hz	Ilk			1	mA
Courant minimum de charge / Minimum load current		Iemin	5			mA
Temps de fermeture / Turn on time	@Ue typ, 50Hz	ton max			0,05	ms
Temps d'ouverture / Turn off time	@Ue typ, 50Hz	toff max			10	ms
Fréquence utilisation / Operating frequency range	F mains	f	0,1	50-60	800	Hz
dv/dt à l'état bloqué / Off state dv/dt		dv/dt	500			V/μs
di/dt max / Maximum di/dt non repetitive		di/dt			50	A/μs
I _{zt} (<10ms)		I _{zt}	1500	2500		A ² s
Immunité / Conducted immunity level	IEC/EN61000-4-4 (bursts)		2kV criterion A			
Immunité / Conducted immunity level	IEC/EN61000-4-5 (surge)		2kV criterion A with VDR			
Protection court-circuit / Short circuit protection	voir/see page 6	Example	Fuse Ferraz gRC 25A/32A/50A			

Caractéristiques générales / General characteristics (at 25°C)	Symbol		
Isolement entrée/sortie - Input to output insulation	Ui	4000	VRMS
Isolation sortie/ semelle - Output to case insulation	Ui	4000	VRMS
Résistance Isolement / Insulation resistance	Ri	1000 (@500VDC)	MΩ
Tenue aux tensions de chocs / Rated impulse voltage	Uimp	4000	V
Degré de protection / Protection level / CEI529		IP20	
Degré de pollution / Pollution degree	-	2	
Vibrations / Vibration withstand 10 -55 Hz according to CEI68	double amplitude	1,5	mm
Tenue aux chocs / Shocks withstand according to CEI68	-	30/50	g
Température de fonctionnement / Ambient temperature (no icing, no condensation)	-	-40/+100	°C
Température de stockage / Storage temperature (no icing, no condensation)		-40/+125	°C
Humidité relative / Ambient humidity	HR	40 to 85	%
Poids / Weight		65	g
Conformité / Conformity		EN60947-4-3 (IEC947-4-3)	
Conformité / Conformity		VDE0805/EN60950 UL/cUL	
plastique du boîtier / Housing Material		PA 6 UL94VO	
Semelle / Base plate		Aluminium, nickel-plated	



ISO 9001
N° 1993/1106a

celduc[®]
r e l a i s

www.celduc.com

Rue Ampère B.P. 4 42290 SORBIERS - FRANCE E-Mail : celduc-relais@celduc.com
Fax +33 (0) 4 77 53 85 51 Service Commercial France Tél. : +33 (0) 4 77 53 90 20
Sales Dept.For Europe Tel. : +33 (0) 4 77 53 90 21 Sales Dept. Asia : Tél. +33 (0) 4 77 53 90 19

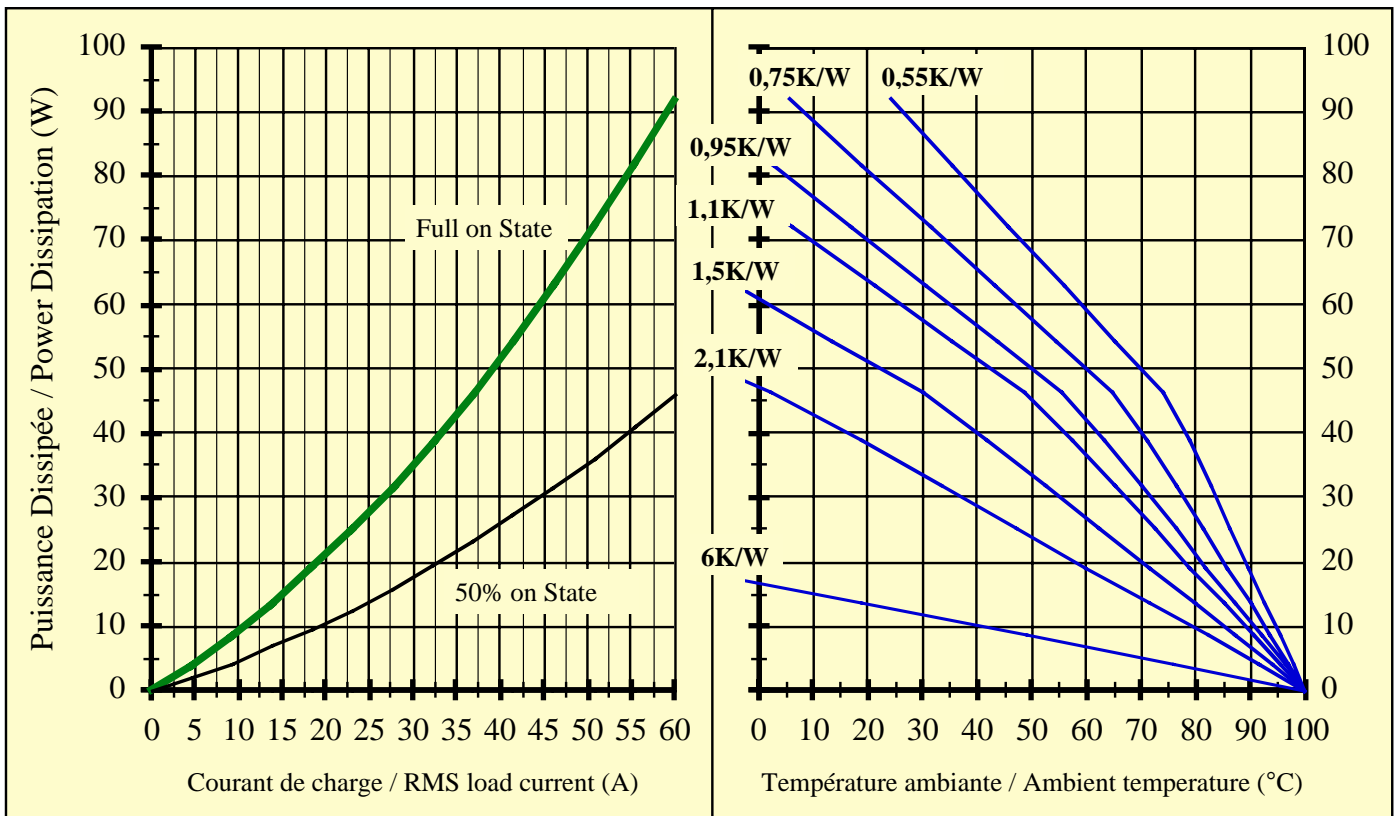
Fig. 2 Courbes thermiques & Choix dissipateur thermique / *Thermal curves and heatsink choice*

12K/W correspond à un relais sans dissipateur monté dans l'air / 12K/W corresponds to a relay without heatsink .

6K/W correspond à un relais monté sur un adaptateur DIN **celduc** type 1LD12020

6K/W corresponds to a relay mounted on a DIN rail adaptor like **celduc** 1LD12020

fig 3 : Courants de surcharges / *Overload currents*

1 -Itsm non répétitif sans tension réappliquée est donné pour la détermination des protections.

1 - *No repetitive Itsm is given without voltage reapplied. This curve is used to define the protection (fuses).*

2 -Itsm répétitif est donné pour des surcharges de courant (T_j initiale=70°C).

Attention : la répétition de ces surcharges de courant diminue la durée de vie du relais.

2 - *Repetitive Itsm is given for inrush current with initial $T_j = 70^\circ\text{C}$. In normal operation, this curve mustn't be exceeded.*

Be careful, the repetition of the surge current decreases the life expectancy of the SSR.

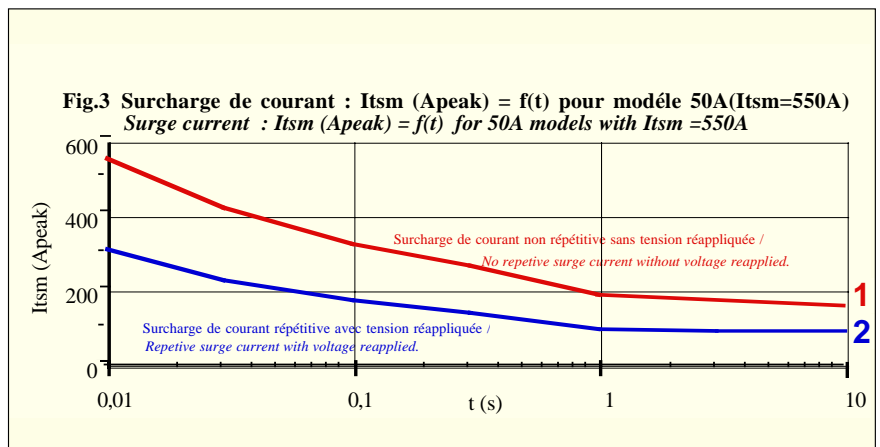
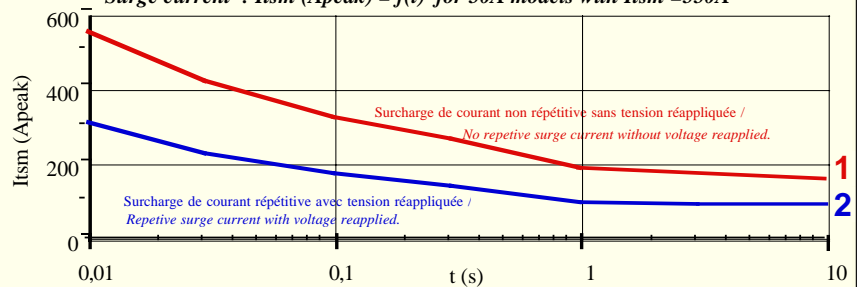

Fig.3 Surcharge de courant : $It_{sm} (A_{peak}) = f(t)$ pour modèle 50A ($It_{sm}=550A$)
Surge current : $It_{sm} (A_{peak}) = f(t)$ for 50A models with $It_{sm}=550A$



-> **Attention !** les relais à semi-conducteurs ne procurent pas d'isolation galvanique entre le réseau et la charge. Ils doivent être utilisés associés à un disjoncteur avec propriété de sectionnement ou similaire, afin d'assurer un sectionnement fiable en amont de la ligne dans l'hypothèse d'une défaillance et pour tous les cas où le relais doit être isolé du réseau (maintenance ; non utilisation sur une longue durée...).

-> **Warning !** semiconductor relays don't provide any galvanic insulation between the load and the mains. Always use in conjunction with an adapted circuit breaker with isolation feature or a similar device in order to ensure a reliable insulation in the event of wrong function and when the relay must be insulated from the mains (maintenance ; if not used for a long duration ...).



ISO 9001
N° 1993/1106a

celduc[®]
r e l a i s

www.celduc.com

Rue Ampère B.P. 4

42290 SORBIERS - FRANCE

E-Mail : celduc-relais@celduc.com

Fax +33 (0) 4 77 53 85 51

Service Commercial France Tél. : +33 (0) 4 77 53 90 20

Sales Dept.For Europe Tel. : +33 (0) 4 77 53 90 21



Sales Dept. Asia : Tél. +33 (0) 4 77 53 90 19

Raccordement / Connections

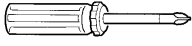
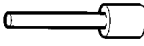
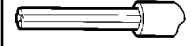
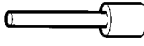

Directement avec fils avec ou sans embouts/
Direct connection with wires with or without ferrules

Avec cosses/
With ring terminals

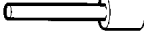
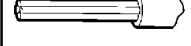
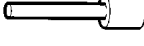
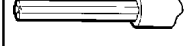

okpac® Raccordement d'entrée / Control wiring				Modèle de tournevis / Screwdriver type	Couple de serrage recommandé Recommended Torque
1		2			
Fil rigide (sans embout) SOLID (No ferrule)	Fil multibrins (avec embout) FINE STRANDED (With ferrule)	Fil rigide (sans embout) SOLID (No ferrule)	Fil multibrins (avec embout) FINE STRANDED (With ferrule)	 POZIDRIV 2	M4
 0,75 ... 2,5 mm ² AWG18...AWG14	 0,75 ... 2,5 mm ² AWG18...AWG14	 0,75 ... 2,5 mm ² AWG18...AWG14	 0,75 ... 2,5 mm ² AWG18...AWG14		N.m
					1,2

okpac® Raccordement de puissance / Power wiring				Modèle de tournevis / Screwdriver type	Couple de serrage recommandé Recommended Torque
1		2			
Fil rigide (sans embout) SOLID (No ferrule)	Fil multibrins (avec embout) FINE STRANDED (With ferrule)	Fil rigide (sans embout) SOLID (No ferrule)	Fil multibrins (avec embout) FINE STRANDED (With ferrule)	 POZIDRIV 2	M5
 1,5 ... 10 mm ² AWG16...AWG8	 1,5 ... 6 mm ² AWG16...AWG10	 1,5 ... 10 mm ² AWG16...AWG8	 1,5 ... 6 mm ² AWG16...AWG10		N.m
					2

<p>Puissance avec cosses / Power with ring terminals.</p>  <p>W max =12,6mm</p> <p>16 mm² (AWG6)</p> <p>25 mm² (AWG4)</p> <p>35mm² (AWG2 /AWG3)</p> <p>50mm² (AWG0 /AWG1)</p> <p>Des cosses et kits d'adaptation peuvent être fournis : voir relais forte puissance et documentation connexion forte puissance/ Suitable ring terminals and special kit for high current can be delivered: see high power SSR and data-sheet for power connexion.</p>	<p>Options : FASTONS : Nous consulter/ Consult us</p> <p>KIT adaptation fort courant / Special kit for high current:</p> <p>1LK00700</p> <p>35mm² (AWG2)</p> <p>50mm² (AWG0)</p>  <p>Pour les forts courants, le volet doit être enlevé (perte IP20). For high currents, power flap must be removed (no IP20)</p>
--	--

Montage /Mounting:

-> Les relais statiques de la gamme **okpac[®]** doivent être montés sur dissipateur thermique. Une gamme étendue de dissipateurs est disponible. Voir exemples ci dessous et la gamme "WF" sur www.celduc.com.

okpac[®] SSRs must be mounted on heatsinks. A large range of heatsinks is available. See below some examples and "WF" range on www.celduc.com.

-> Pour le montage du relais sur dissipateur utiliser de la graisse thermique ou un "thermal pad" haute performance spécifié par **celduc[®]**. Une version autocollante précollée sur le relais est aussi disponible: nous consulter / For heatsink mounting, it is necessary to use thermal grease or thermal pad with high conductivity specified by **celduc[®]**. An adhesive model mounted by **celduc[®]** on the SSR is also available: please contact us.

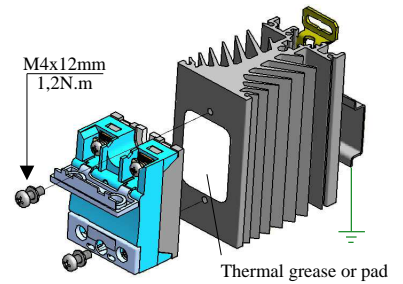

WF151200
(2-2,5 K/W)



WF108110
(1,1 K/W)

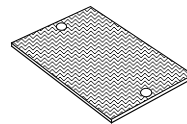

Thermal pad :
5TH21000

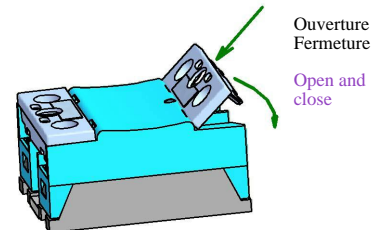

Volets IP20
/ IP20 flaps

Applications

